

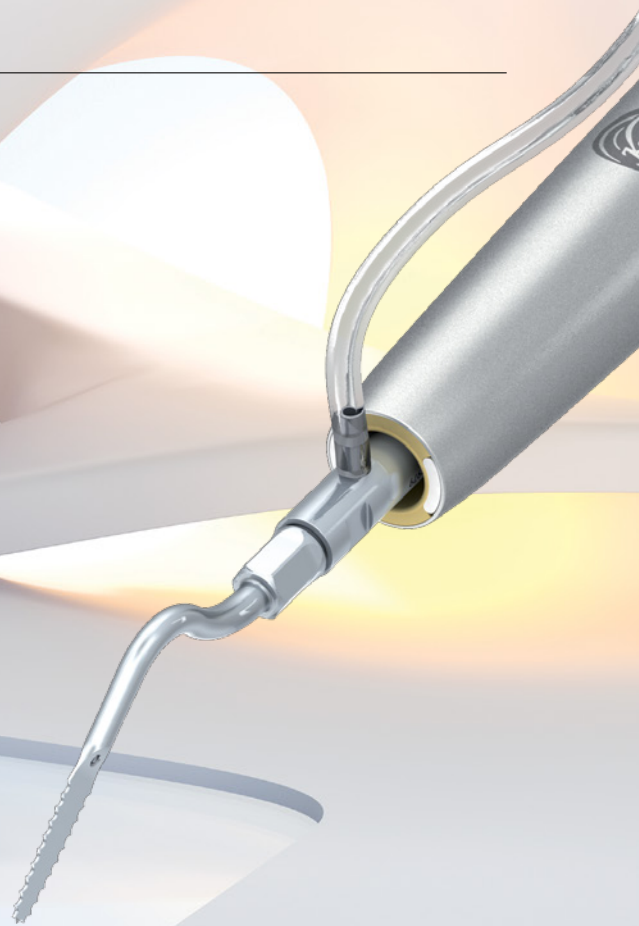

Chirurgie *Surgery*





Wissenschaftliche Beratung:

Dr. Ivo Agabiti, Pesaro, Italien

Dr. Martin Dürholt,
Bad Salzungen

Dr. Stefan Neumeyer,
Eschlkam

Dr. med. dent. Marcus Striegel,
Dr. Thomas Schwenk,
Nürnberg

Scientific advice:

Dr. Ivo Agabiti, Pesaro, Italy

*Dr. Martin Dürholt,
Bad Salzungen, Germany*

*Dr. Stefan Neumeyer,
Eschlkam, Germany*

*Dr. med. dent. Marcus Striegel,
Dr. Thomas Schwenk,
Nuremberg, Germany*

Brasseler®, Komet®, CeraBur®, CeraCut®, CeraDrill®, CeraFusion®, CeraPost®, DC1®, DCTherm®, F360®, F6 SkyTaper®, H4MC®, OptiPost®, PolyBur® sind eingetragene Marken der Gebr. Brasseler GmbH & Co. KG.

Die im Text genannten Produkte und Bezeichnungen sind zum Teil marken-, patent- und urheberrechtlich geschützt. Aus dem Fehlen eines besonderen Hinweises bzw. des Zeichens ® darf nicht geschlossen werden, dass kein rechtlicher Schutz besteht.

Dieses Werk ist urheberrechtlich geschützt. Alle Rechte, auch die der Übersetzung, des Nachdrucks und der Vervielfältigung auch von Teilen daraus, sind vorbehalten. Kein Teil des Werkes darf ohne schriftliche Genehmigung des Herausgebers in irgendeiner Form (Fotokopie, Mikrofilm oder ein anderes Verfahren), reproduziert oder unter Verwendung elektronischer Systeme verarbeitet werden.

Produkt- und Farbänderungen sowie Druckfehler vorbehalten.

Stand: Dezember 2021

Brasseler®, Komet®, CeraBur®, CeraCut®, CeraDrill®, CeraFusion®, Cerapost®, DC1®, DCTherm®, F360®, F6 SkyTaper®, H4MC®, OptiPost®, Polybur® are registered trademarks of Gebr. Brasseler GmbH & Co. KG.

Some of the products and designations mentioned in the text are trademarked, patented or copyrighted. The absence of a special reference or the sign ® should not be interpreted as the absence of legal protection.

This publication is copyrighted. All rights, also with regard to translation, reprint and reproduction (also in the form of extracts) are reserved. No part of this publication may be reproduced or reprocessed using electronic systems in any form or by any means (photocopying, microfilm or other methods) without the written permission of the editor.

Colours and products are subject to alterations. Printing errors excepted.

As at December 2021

	Chirurgische Knochenfräser <i>Surgical bone cutters</i>
4 – 14	Knochenfräser aus Hartmetall <i>Bone cutters made of tungsten carbide</i>
15	Knochenfräser aus Keramik <i>Bone cutters made of ceramics</i>
16 – 17	Knochenfräser diamantiert <i>Bone cutters diamond-coated</i>
18 – 22	Periimplantitis-Instrumente <i>Periimplantitis instruments</i>
23 – 25	Universelle Pilotbohrer <i>Universal pilot burs</i>
26 – 28	Knochengewinnung <i>Bone harvesting</i>

	Chirurgische Schallspitzen <i>Surgical sonic tips</i>
29 – 32	SonicLine Chirurgie <i>SonicLine Surgery</i>
33 – 35	Sinuslift <i>Sinus lift</i>
36	Knochenbearbeitung <i>Bone preparation</i>
37 – 40	Schallspitzen für die chirurgische Kronenverlängerung <i>Sonic tips for surgical crown extension</i>

	Zubehör <i>Auxiliaries</i>
41 – 46	Instrumentenständer aus Edelstahl <i>Stainless steel bur blocks</i>
47 – 50	Zubehör <i>Auxiliaries</i>
51	Klinischer Fall <i>Clinical case</i>



Chirurgie

Surgery

Komet offers a wide variety of bone cutters made of tungsten carbide, ceramics, diamond instruments and "Miniflex" discs for bone treatments. The instrument shapes were designed to suit the requirements of different indications. The high-quality instruments made by Komet are synonymous for outstanding clinical results and minimally invasive, efficient preparations. We are particularly proud of our most recently developed innovations: our bone cutters H254E and H162SL. Introduced in 2015, the H162ST is a well thought-out enhanced version of the established bone cutter type Lindemann. It is particularly appreciated for its extremely sharp, innovative ST toothing exclusive to Komet. Periimplantitis: Particularly long instruments are available for the smoothing of implants during periimplantitis treatments using resective surgery.

Range of instruments:

- Bone cutters
- Periimplantitis instruments
- Miniflex bone saw
- Universal pilot burs
- Trepan burs
- Bone chip extractors
- Bur blocks

Hard ZrN coating

Many bone cutters are also available as an enhanced version with a special ZrN coating. Thanks to this coating, the cutters are better equipped against the effects of potentially aggressive chemicals in the bur bath. What's more, many users are impressed with the pleasant appearance of the instruments.

In vielfältiger Auswahl stehen Knochenfräser aus Hartmetall, Keramik, diamantierte Instrumente und die „Miniflex“-Scheibe für die Knochenbearbeitung zur Verfügung. Die Formen berücksichtigen dabei die unterschiedlichen Anforderungen, die sich durch die verschiedenen Indikationen ergeben. Die Instrumente verfügen allesamt über den hohen Komet Qualitätsstandard und stehen für gute Ergebnisse und eine minimal-invasive, effektive Präparationsleistung. Erfolgreiche Beispiele aktueller Entwicklungen sind unsere Knochenfräser H254E und H162SL. Seit 2015 glänzt der H162ST als besonders gelungene Weiterentwicklung des Knochenfräasers Typ Lindemann – mit der exklusiven, maximal schnittfreudigen innovativen Komet ST-Verzahnung. Periimplantitis: für die Implantatglättung bei chirurgisch resektiver Strategie stehen bewusst lange Instrumente zur Verfügung.

Instrumentenprogramm:

- Knochenfräser
- Periimplantitis-Instrumente
- Miniflex Knochensäge
- Universelle Pilotbohrer
- Trepanbohrer
- Knochenspanbohrer
- Instrumentenständer

ZrN Hartbeschichtung

Viele Knochenfräser stehen auch als veredelte Variante mit spezieller ZrN-Beschichtung zur Verfügung. Sie widerstehen möglicherweise aggressiven Einflüssen eines chemischen Bohrerbades besser. Auch das angenehme visuelle Feedback befürworten viele Anwender.

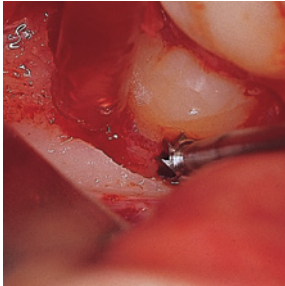

H 141

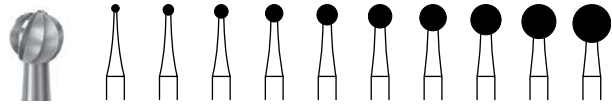

		5	5	5	5	5	5	5	5	5	
Größe · Size	Ø 1/10 mm	010	014	018	023	027	031	035	040	045	050
US No.		2S	4S	6S	8S	10S	11S	-	-	-	-

Winkelstück lang · Right-angle long (RAL)



500 205 001291 ...

H141.205. ...

	010	014	018	023	027	031	035	040	-	-
--	-----	-----	-----	-----	-----	-----	-----	-----	---	---

Winkelstück extra lang · Right-angle extra-long (RAXL)



500 206 001291 ...

H141.206. ...

	010	014	018	023	027	031	035	040	-	-
--	-----	-----	-----	-----	-----	-----	-----	-----	---	---

Handstück · Handpiece (HP)

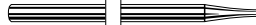

500 104 001291 ...

H141.104. ...

	010	014	018	023	027	031	035	040	045	050
--	-----	-----	-----	-----	-----	-----	-----	-----	-----	-----

Handstück lang · Handpiece long (HPL)



500 105 001291 ...

H141.105. ...

	010	014	018	023	027	031	035	040	-	050
--	-----	-----	-----	-----	-----	-----	-----	-----	---	-----

◆ = \odot_{\max} 60000 min⁻¹/rpm

◆ = \odot_{\max} 80000 min⁻¹/rpm

■ = \odot_{\max} 100000 min⁻¹/rpm

Knochenfräser rund, schnittfreundige Ausführung

Bone cutter round, high-efficiency cutting design

H 141 Z

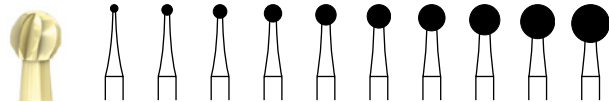

		5	5	5	5	5	5	5	5	5	
Größe · Size	Ø 1/10 mm	010	014	018	023	027	031	035	040	045	050

Handstück · Handpiece (HP)



H141Z.104. ...

	010	014	018	023	027	031	035	040	045	050
--	-----	-----	-----	-----	-----	-----	-----	-----	-----	-----

◆ = \odot_{\max} 80000 min⁻¹/rpm

■ = \odot_{\max} 100000 min⁻¹/rpm

Knochenfräser rund, schnittfreundige Ausführung, ZrN beschichtet

Bone cutter round, high-efficiency cutting design, ZrN coated

H 141 A

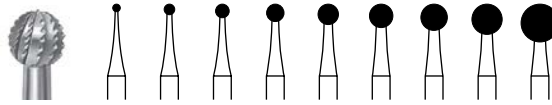

		5	5	5	5	5	5	5	5	5
Größe · Size	Ø 1/10 mm	010	014	018	023	027	031	035	040	050
US No.		-	-	-	8SA	10SA	11SA	-	-	-

Winkelstück lang · Right-angle long (RAL)



500 205 001298 ...

H141A.205. ...

-	014	018	023	027	031	035	040	-
---	-----	-----	-----	-----	-----	-----	-----	---

Winkelstück extra lang · Right-angle extra-long (RAXL)



500 206 001298 ...

H141A.206. ...

010	014	018	023	027	031	035	040	-
-----	-----	-----	-----	-----	-----	-----	-----	---

Handstück · Handpiece (HP)



500 104 001298 ...

H141A.104. ...

010	014	018	023	027	031	035	040	050
-----	-----	-----	-----	-----	-----	-----	-----	-----

◆ = \varnothing_{max} 60000 min⁻¹/rpm

◆ = \varnothing_{max} 80000 min⁻¹/rpm

■ = \varnothing_{max} 100000 min⁻¹/rpm

Knochenfräser rund, mit speziellem Schneidendesign für ruhigen Lauf

Bone cutter round, with special cutting design for smooth operation

H 141 AZ

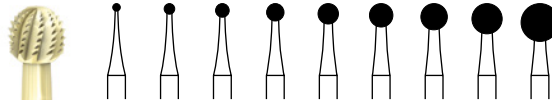

		5	5	5	5	5	5	5	5	5
Größe · Size	Ø 1/10 mm	010	014	018	023	027	031	035	040	050

Winkelstück lang · Right-angle long (RAL)



H141AZ.205. ...

-	014	018	023	027	031	035	040	-
---	-----	-----	-----	-----	-----	-----	-----	---

Handstück · Handpiece (HP)



H141AZ.104. ...

010	014	018	023	027	031	035	040	050
-----	-----	-----	-----	-----	-----	-----	-----	-----

◆ = \varnothing_{max} 80000 min⁻¹/rpm

■ = \varnothing_{max} 100000 min⁻¹/rpm

Knochenfräser rund, mit speziellem Schneidendesign für ruhigen Lauf, ZrN beschichtet

Bone cutter round, with special cutting design for smooth operation, ZrN coated

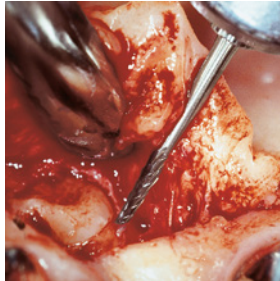
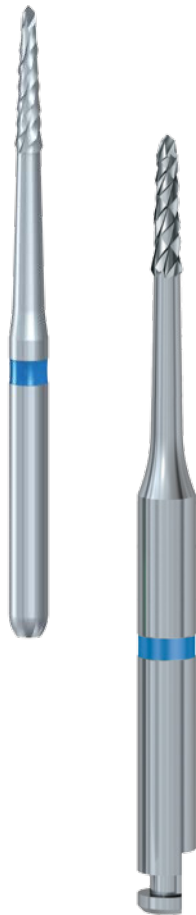

Für Knochengewebe und
Zahnhartsubstanz
Knochenfräser
*For bone tissue and hard tooth
substance*
Bone cutter

- H 254 E
- H 254 LE



	5
Größe · Size	Ø 1/10 mm 012
L	mm 6,0

FG - Friction Grip (FG)



500 314 415298 ...

- H254E.314. ... ◀012

500 314 415298 ...

- H254LE.314. ... ◀012

Winkelstück · Right-angle (RA)



500 204 415298 ...

- H254E.204. ... ◀012

Winkelstück lang · Right-angle long (RAL)



500 205 415298 ...

- H254E.205. ... ◀012

Handstück · Handpiece (HP)



500 104 415298 ...

- H254E.104. ... ◀012

◊ = \odot_{\max} 40000 min⁻¹/rpm

◈ = \odot_{\max} 80000 min⁻¹/rpm

Kombinationsinstrument für die schonende Präparation
von Knochengewebe und Zahnhartsubstanz
*Combination instrument for conservative preparation of
bone tissue and hard tooth substance*

H 254

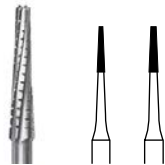

	5	5
Größe · Size	Ø 1/10 mm 010	012
L	mm 6,0	6,0
US No.	700XXL	701XXL

FG - Friction Grip (FG)



500 314 415296 ...

- H254.314. ... 010 012

\odot_{\max} 80000 min⁻¹/rpm

Knochenfräser für Blattimplantate
Bone cutter for leaf implants



H 255 E



	5
Größe · Size	Ø 1/10 mm 012
L	mm 6,0

FG - Friction Grip (FG)



- H255E.314. ... ◀012

FG extra lang · Friction Grip extra-long
(FGXL)



- H255E.316. ... ◀012

Winkelstück · Right-angle (RA)



- H255E.204. ... ◀012

Handstück · Handpiece (HP)



- H255E.104. ... ◀012

◊ = \odot_{\max} 40000 min⁻¹/rpm

◈ = \odot_{\max} 80000 min⁻¹/rpm

Knochenfräser zylindrisch für die effektive Präparation
von Knochengewebe und Zahnhartsubstanz
*Cylindrical bone cutter for efficient preparation of bone
tissue and hard tooth substance*

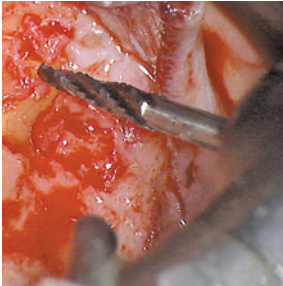

- H 162 SL
- H 162 SXL



		5
Größe · Size	Ø 1/10 mm	014
L	mm	8,0

FG - Friction Grip (FG)



- H162SL.314. ... 014

- H162SXL.314. ... 014

Winkelstück · Right-angle (RA)



- H162SL.204. ... 014

Handstück · Handpiece (HP)



- H162SL.104. ... 014

◇ = max. 40000 min⁻¹/rpm

■ = max. 100000 min⁻¹/rpm

▣ = max. 120000 min⁻¹/rpm

▤ = max. 160000 min⁻¹/rpm

Knochenfräser, besonders schnittfreudig

Bone cutter with high-efficiency cutting design



H 163 A



		5
Größe · Size	Ø 1/10 mm	014
L	mm	5,0

Winkelstück · Right-angle (RA)



- H163A.204. ... 014

Handstück · Handpiece (HP)

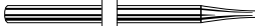

- H163A.104. ... 014

○ max. 100000 min⁻¹/rpm

Knochenfräser, Lindemann kurz, mit spezieller Kreuzverzahnung

Bone cutter, Lindemann short, with special staggered toothing

H 33 L

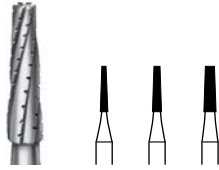

			5	5	5
Größe · Size	Ø 1/10 mm		010	012	016
L	mm		6,0	6,0	6,0
US No.			700XL	701L	702L

FG extra lang · Friction Grip extra-long
(FGXL)



500 316 171007 ...

H33L.316. ...

010 012 016

⊖_{max} 100000 min⁻¹/rpm
 Konisch lang mit Querhieb
 Tapered long with cross cut

H 33 R



			5
Größe · Size	Ø 1/10 mm		016
L	mm		4,4
US No.			1702

FG extra lang · Friction Grip extra-long
(FGXL)



500 316 194007 ...

H33R.316. ...

016

⊖_{max} 100000 min⁻¹/rpm
 Konisch mit abgerundeter Spitze und Querhieb
 Tapered with round end and cross cut



Knochenfräser H162ST

Bone cutter H162ST

A new cut, a new generation: Sharp as the teeth of the proverbial sabre tooth tiger, Komet's new ST tothing makes work with the H162ST a completely new experience. This tapered bone cutter is particularly effective and cuts with unrivalled, perfect sharpness.

The advantages at a glance:

- Perfect sharpness
- Ideal cutting behavior
- Maximum control

The instrument is suitable for all sectors of dental surgery: From bone cuts during an osteotomy via hemisections and axial bone perforations to the surgical removal of retained teeth or root fragments.

An enhanced version of the H162ST with high-grade ZrN coating is optionally available under reference H162STZ.

Neuer Schnitt, neue Generation: die sprichwörtlich säbelzahn timerscharfe neue ST-Verzahnung von Komet sorgt bei diesem konischen Knochenfräser für ein ganz neues Schneidgefühl. Das Instrument schneidet mit besonders spürbarer Effektivität in höchster und damit perfekter Schnittschärfe.

Die Vorteile auf einen Blick:

- perfekte Schnittschärfe
- ideales Schneidverhalten
- maximale Kontrolle

Geeignet für alle Einsatzfelder der zahnärztlichen Chirurgie: für Knochenschnitte im Rahmen einer Osteotomie, für die Hemisektion, die knöchernen axiale Perforation, für die chirurgische Entfernung retinierter Zähne oder die Entfernung von Wurzelresten.

Der H162ST ist wahlweise auch als veredelte Variante mit hochwertiger ZrN-Beschichtung als H162STZ erhältlich.

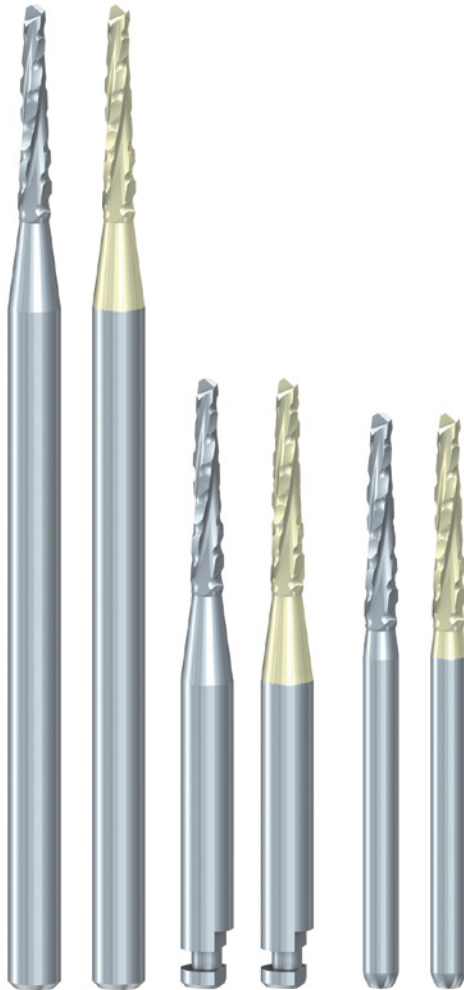

H 162 ST



		5
Größe · Size	Ø 1/10 mm	016
L	mm	9,0

FG · Friction Grip (FG)



H162ST.314. ... ■016

Winkelstück · Right-angle (RA)



H162ST.204. ... ■016

Handstück · Handpiece (HP)



H162ST.104. ... ■016

- = \bigcirc_{max} 100000 min⁻¹/rpm
- = \bigcirc_{max} 160000 min⁻¹/rpm

Knochenfräser konisch, höchste Schnittschärfe dank spezieller ST-Verzahnung
Bone cutter tapered, maximum cutting performance thanks to special ST-tothing

H 162 STZ



		5
Größe · Size	Ø 1/10 mm	016
L	mm	9,0

FG · Friction Grip (FG)



H162STZ.314. ... ■016

Winkelstück · Right-angle (RA)



H162STZ.204. ... ■016

Handstück · Handpiece (HP)

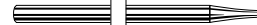

H162STZ.104. ... ■016

- = \bigcirc_{max} 100000 min⁻¹/rpm
- = \bigcirc_{max} 160000 min⁻¹/rpm

Knochenfräser konisch, höchste Schnittschärfe dank spezieller ST-Verzahnung, ZrN beschichtet
Bone cutter tapered, maximum cutting performance thanks to special ST-tothing, ZrN coated

H 162 A

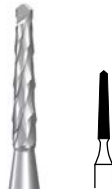

		5
Größe · Size	Ø 1/10 mm	016
L	mm	9,0

FG · Friction Grip (FG)



500 314 408298 ...

H162A.314. ... ■016

Winkelstück · Right-angle (RA)



500 204 408298 ...

H162A.204. ... ■016

Winkelstück lang · Right-angle long (RAL)



500 205 408298 ...

H162A.205. ... ■016

Handstück · Handpiece (HP)



500 104 408298 ...

H162A.104. ... ■016

■ = \odot_{\max} 100000 min⁻¹/rpm

■ = \odot_{\max} 160000 min⁻¹/rpm

Knochenfräser, Lindemann, mit spezieller Kreuzverzahnung

Bone cutter, Lindemann, with special staggered tooting

H 162 AZ

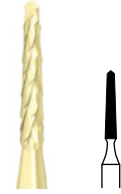

		5
Größe · Size	Ø 1/10 mm	016
L	mm	9,0

FG · Friction Grip (FG)



H162AZ.314. ... ■016

Winkelstück · Right-angle (RA)



H162AZ.204. ... ■016

Winkelstück lang · Right-angle long (RAL)



H162AZ.205. ... ■016

Handstück · Handpiece (HP)

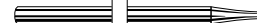

H162AZ.104. ... ■016

■ = \odot_{\max} 100000 min⁻¹/rpm

■ = \odot_{\max} 160000 min⁻¹/rpm

Knochenfräser, Lindemann, mit spezieller Kreuzverzahnung, ZrN beschichtet

Bone cutter, Lindemann, with special staggered tooting, ZrN coated

H 162



		5
Größe · Size	Ø 1/10 mm	016
L	mm	9,0

FG · Friction Grip (FG)



500 314 408297 ...

H162.314. ... ■016

Winkelstück · Right-angle (RA)



500 204 408297 ...

H162.204. ... ■016

Winkelstück lang · Right-angle long (RAL)



500 205 408297 ...

H162.205. ... ■016

Handstück · Handpiece (HP)

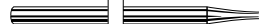

500 104 408297 ...

H162.104. ... ■016

■ = \odot_{\max} 100000 min⁻¹/rpm

■ = \odot_{\max} 160000 min⁻¹/rpm

Knochenfräser, Lindemann

Bone cutter, Lindemann

H 162 Z

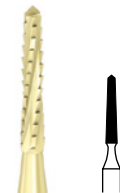

		5
Größe · Size	Ø 1/10 mm	016
L	mm	9,0

FG · Friction Grip (FG)



H162Z.314. ... ■016

Winkelstück · Right-angle (RA)



H162Z.204. ... ■016

Winkelstück lang · Right-angle long (RAL)



H162Z.205. ... ■016

Handstück · Handpiece (HP)



H162Z.104. ... ■016

■ = \odot_{\max} 100000 min⁻¹/rpm

■ = \odot_{\max} 160000 min⁻¹/rpm

Knochenfräser, Lindemann, ZrN beschichtet

Bone cutter, Lindemann, ZrN coated

H 267



		5
Größe · Size	Ø 1/10 mm	016
L	mm	9,0

FG - Friction Grip (FG)



500 314 210295 ...

H267.314. ...

016

Handstück · Handpiece (HP)



500 104 210295 ...

H267.104. ...

016

- = \odot_{\max} 100000 min⁻¹/rpm
- = \odot_{\max} 160000 min⁻¹/rpm

Knochenfräser
Bone cutter

H 269



		5
Größe · Size	Ø 1/10 mm	016
L	mm	11,0

FG - Friction Grip (FG)



500 314 199295 ...

H269.314. ...

016

\odot_{\max} 160000 min⁻¹/rpm

Knochenfräser
Bone cutter

H 269 Q



		5
Größe · Size	Ø 1/10 mm	016
L	mm	11,0

FG - Friction Grip (FG)



H269Q.314. ...

016

FG lang · Friction Grip long (FGL)



H269Q.315. ...

016

\odot_{\max} 160000 min⁻¹/rpm

Knochenfräser
Bone cutter

H 161



		5
Größe · Size	Ø 1/10 mm	016
L	mm	9,0

FG - Friction Grip (FG)



500 314 408295 ...

H161.314. ...

016

Handstück · Handpiece (HP)



500 104 408295 ...

H161.104. ...

016

- = \odot_{\max} 100000 min⁻¹/rpm
- = \odot_{\max} 160000 min⁻¹/rpm

Knochenfräser, Lindemann
Bone cutter, Lindemann

H 166 ST



		5
Größe · Size	Ø 1/10 mm	021
L	mm	10,0

Handstück · Handpiece (HP)



H166ST.104. ...

021

⊖_{max.} 100000 min⁻¹/rpm
 Knochenfräser konisch, höchste Schnittschärfe dank spezieller ST-Verzahnung
Bone cutter tapered, maximum cutting performance thanks to special ST-toothing

H 166 STZ

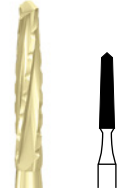

		5
Größe · Size	Ø 1/10 mm	021
L	mm	10,0

Handstück · Handpiece (HP)



H166STZ.104. ...

021

⊖_{max.} 100000 min⁻¹/rpm
 Knochenfräser konisch, höchste Schnittschärfe dank spezieller ST-Verzahnung, ZrN beschichtet
Bone cutter tapered, maximum cutting performance thanks to special ST-toothing, ZrN coated

H 166 A



		5
Größe · Size	Ø 1/10 mm	021
L	mm	10,0

Winkelstück · Right-angle (RA)



500 204 409298 ...

H166A.204. ...

021

Winkelstück lang · Right-angle long (RAL)



500 205 409298 ...

H166A.205. ...

021

Handstück · Handpiece (HP)

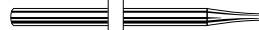

500 104 409298 ...

H166A.104. ...

021

⊖_{max.} 100000 min⁻¹/rpm
 Knochenfräser, Lindemann, mit spezieller Kreuzverzahnung
Bone cutter, Lindemann, with special staggered toothing

H 166 AZ

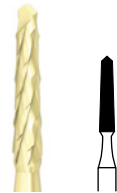

		5
Größe · Size	Ø 1/10 mm	021
L	mm	10,0

Winkelstück · Right-angle (RA)



H166AZ.204. ...

021

Winkelstück lang · Right-angle long (RAL)

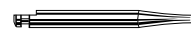

H166AZ.205. ...

021

Handstück · Handpiece (HP)

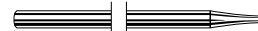

H166AZ.104. ...

021

⊖_{max.} 100000 min⁻¹/rpm
 Knochenfräser, Lindemann, mit spezieller Kreuzverzahnung, ZrN beschichtet
Bone cutter, Lindemann, with special staggered toothing, ZrN coated

H 166



		5
Größe · Size	Ø 1/10 mm	021
L	mm	10,0

Winkelstück · Right-angle (RA)



500 204 409297 ...

H166.204. ...

021

Winkelstück lang · Right-angle long (RAL)

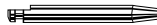

500 205 409297 ...

H166.205. ...

021

Handstück · Handpiece (HP)



500 104 409297 ...

H166.104. ...

021

○_{max} 100000 min⁻¹/rpm
Knochenfräser, Lindemann
Bone cutter, Lindemann

H 166 Z

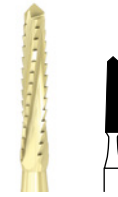

		5
Größe · Size	Ø 1/10 mm	021
L	mm	10,0

Handstück · Handpiece (HP)



H166Z.104. ...

021

○_{max} 100000 min⁻¹/rpm
Knochenfräser, Lindemann, ZrN beschichtet
Bone cutter, Lindemann, ZrN coated

H 167



		5
Größe · Size	Ø 1/10 mm	023
L	mm	11,0

Handstück · Handpiece (HP)



500 104 410297 ...

H167.104. ...

023

○_{max} 80000 min⁻¹/rpm
Knochenfräser, Lindemann
Bone cutter, Lindemann

H 207 D



		5
Größe · Size	Ø 1/10 mm	012
US No.		958D

FG extra lang · Friction Grip extra-long
(FGXL)



500 316 150001 ...

H207D.316. ...

012

○_{max} 300000 min⁻¹/rpm
Stufenbohrer zur Reduzierung des Knochens im
Rahmen einer chirurgischen Kronenverlängerung zur
Wiederherstellung der biologischen Breite oder zur
Schaffung eines flachen Präparationsbodens in der
Kavität, Lasermarkierung bei 4 mm
End-cutting bur for reducing bone substance during
surgical crown extension, for recreating the natural
biological width or for creating a flat preparation floor in
the cavity, laser marking at 4 mm



CeraBur

CeraBur

CeraBur - High efficiency bone cutters made of ceramics

Advantages:

- Corrosion-free
- Biocompatible
- High efficiency cutting
- Smooth, conservative bone material reduction
- The cylindrical operative part of the K157 avoids jamming during preparation



CeraBur - Schnittfreudige Knochenfräser aus Hochleistungskeramik

Zwei Komet Alternativen zu metallischen Knochenfräsern für die Oralchirurgie aus Keramik.

Vorteile:

- korrosionsfrei
- biokompatibel
- hohe Schneidleistung
- gute Sichtbarkeit
- zylindrisches Arbeitsteil des K157 zur Vermeidung des Festsetzens während der Präparation

K 160 A

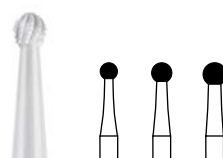

			5	5	5
Größe · Size	Ø 1/10 mm	023	027	031	

Winkelstück lang · Right-angle long (RAL)



K160A.205. ... **023** **027** **031**

Handstück · Handpiece (HP)



K160A.104. ... **023** **027** **031**

⊖_{max.} 40000 min⁻¹/rpm
Gebrauchsmuster, Patente/ Utility model, patents
EP 1 539 018*
* angemeldet/ * pending

Knochenfräser rund, Keramik
Bone cutter round, made of ceramics

K 157



			5
Größe · Size	Ø 1/10 mm	016	
L	mm	9,0	

FG · Friction Grip (FG)



K157.314. ... **016**

Winkelstück · Right-angle (RA)



K157.204. ... **016**

Winkelstück lang · Right-angle long (RAL)



K157.205. ... **016**

Handstück · Handpiece (HP)



K157.104. ... **016**

⊖ = ⊖_{max.} 40000 min⁻¹/rpm
⊖ = ⊖_{max.} 160000 min⁻¹/rpm
Knochenfräser, Keramik
Bone cutter, made of ceramics

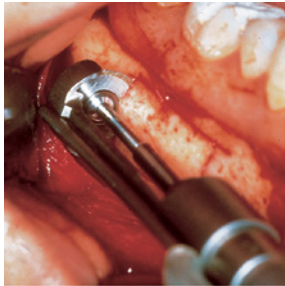

Diamantierte Knochenfräser

Diamond-coated bone cutters

Contrary to cutting instruments, diamond coated cutters work in abrasive mode. The round shape can for example be used for mobilising a lateral bone window as part of a sinus lift.

Diamond disc Miniflex

The extra fine Miniflex diamond disc is most frequently used for splitting a jaw section to widen the alveolar ridge prior to a restoration with an implant. It is equally suitable for removing bone blocks in the region of the jaw angle. Use with disc guard.

Diamantbelegte Instrumente arbeiten im Gegensatz zu schneidenden Fräsern in schleifender Weise. Die runde Form kann u. a. bei der Mobilisierung eines lateralen Knochenfensters im Rahmen einer Sinuslift-OP gewählt werden.

Diamantscheibe Miniflex

Die extrafeine Miniflex Diamantscheibe findet besonders häufige Verwendung bei der Aufspaltung eines Kieferabschnittes zur Kammverbreiterung bei geplanter Implantatversorgung. Auch zur Knochenblockentnahme im Kieferwinkelbereich wird sie herangezogen. Beim Einsatz ist ein Scheibenschutz erforderlich.

242

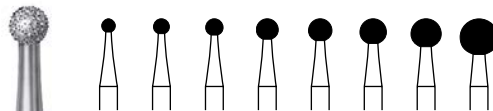

		5	5	5	5	5	5	5	5
Größe · Size	Ø 1/10 mm	018	021	023	029	031	035	040	050

Handstück · Handpiece (HP)



242.104. ...

018 021 023 029 031 035 040 050

◆ = $\text{max. } 80000 \text{ min}^{-1}/\text{rpm}$

■ = $\text{max. } 100000 \text{ min}^{-1}/\text{rpm}$

Diamant, rund

Diamond, round

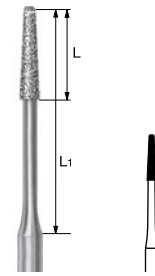

D 254



		5
Größe · Size	Ø 1/10 mm	012
L	mm	6,0
L ₁	mm	15,0

FG · Friction Grip (FG)



D254.314. ...

012

⊖_{max} 100000 min⁻¹/rpm

Diamantfräser für Wurzelspitzenresektion und zum Trennen von Weisheitszähnen

Diamond cutter for apicectomy and separation of wisdom teeth

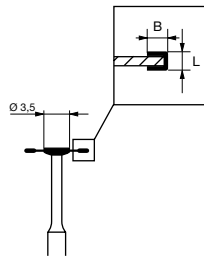

943 CH



		5	5
Größe · Size	Ø 1/10 mm	065	080
Belegung (B) · Coating (B)	mm	0,5	0,5
L	mm	0,29	0,29
D	Ø 1/10 mm	3,5	3,5

Winkelstück · Right-angle (RA)

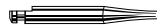

806 204 361524 ...

943CH.204. ...

◇065

◇080

Winkelstück lang · Right-angle long (RAL)



806 205 361524 ...

943CH.205. ...

◇065

◇080

◇ = ⊖_{max} 35000 min⁻¹/rpm

◇ = ⊖_{max} 40000 min⁻¹/rpm

Miniflex Diamant-Schleifscheibe für die Knochendeckelmethode

Wurzelspitzenresektion im Molarenbereich, osteoplastische Kieferhöhlenoperation

Gesamtlängen: Schaft 204 29,3 mm, Schaft 205 41,3 mm

Scheibenschutz verwenden

Miniflex diamond disc for bone-lid method

Apicectomy in the molar area, osteoplastic surgery of the maxillary sinus

Total lengths: shank 204 29.3 mm, shank 205 41.3 mm

Use disc-guard

Periimplantitis NiTiBrush

Periimplantitis NiTiBrush

The perfect decontamination of implant surfaces is of decisive importance for a successful outcome of periimplantitis treatments. At the same time, care has to be taken not to roughen the implant surface.

The NiTiBrush instruments remove biofilms from pure titanium implants.

ICT1, smooth brush: bristles in axial direction.

ICT2, curly brush: radially arranged bristles.

The advantages at a glance:

- highly effective debridement
- up to 40 bristles made of flexible nickel-titanium
- rotary use in the contra-angle
- no additional equipment required

Die vollständige Dekontamination von Implantatoberflächen ist bei der Periimplantitisbehandlung von entscheidender Bedeutung. Wichtig ist zudem, die Implantatoberfläche nicht aufzurauen.

Die NiTiBrush Instrumente befreien Implantate aus Reintitan von Biofilmen.

ICT1 Form Pinsel: mit Borsten in axialer Richtung.

ICT2 Form Bürste: mit radiär angeordneten Borsten.

Die Vorteile auf einen Blick:

- hochwirksames Debridement
- bis zu 40 Borsten aus flexiblem Nickel-Titan
- rotierender Einsatz im Winkelstück
- keine zusätzlichen Geräte erforderlich

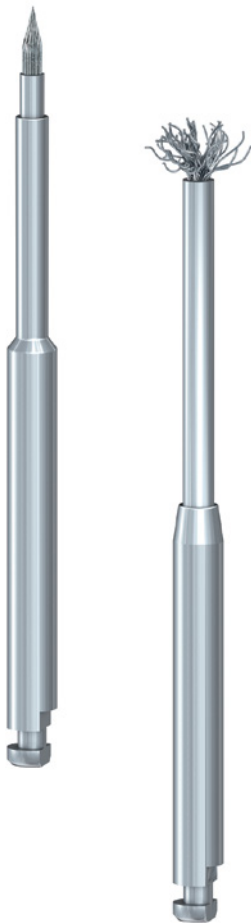

ICTS 12.204



Set NiTiBrush Pinsel und Bürste

NiTiBrush Set - pointed and clustered brushes

ICT1.204.	2	
ICT2.204.	2	

Enthält 2 NiTiBrush Titanbürsten in Pinselform mit Nickel-Titan-Borsten in axialer Richtung und 2 Titanbürsten mit gebogenen Borsten, für die intraorale Reinigung von Titanimplantaten im Rahmen einer chirurgischen Periimplantitisbehandlung
Contains 2 fine, pointed NiTiBrush titanium brushes with nickel-titanium bristles in axial direction and 2 titanium brushes with curved bristles, for intraoral cleaning of titanium implants as part of a surgical periimplantitis treatment



ICT 1



1

Winkelstück - Right-angle (RA)



ICT1.204. ...



⊙_{max} 1200 min⁻¹/rpm

NiTiBrush Titanbürste in Pinselform mit Nickel-Titan-Borsten in axialer Richtung, für die intraorale Reinigung von Titanimplantaten im Rahmen einer chirurgischen Periimplantitisbehandlung, Gesamtlänge 35 mm. Schaft: RF-Stahl

NiTiBrush, pointed titanium brush with nickel-titanium bristles in axial direction, for intraoral cleaning of titanium implants as part of a surgical periimplantitis treatment, total length 35 mm. Shank made of stainless steel



ICT 2



1

Winkelstück - Right-angle (RA)



ICT2.204. ...



⊙_{max} 1200 min⁻¹/rpm

NiTiBrush Titanbürste mit gebogenen Nickel-Titan-Borsten, für die intraorale Reinigung von Titanimplantaten im Rahmen einer chirurgischen Periimplantitisbehandlung, Gesamtlänge 37 mm. Schaft: RF-Stahl

NiTiBrush Titanium brush with curved nickel-titanium bristles, for intraoral cleaning of titanium implants as part of a surgical periimplantitis treatment, total length 37 mm. Shank made of stainless steel

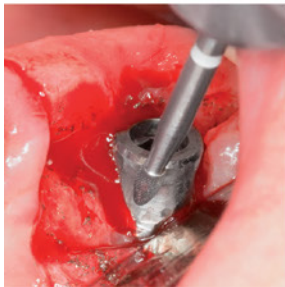

The decontamination of the implant surface is an essential step duringhio periimplantitis treatments using resective surgery.

Macro and micro structures can be effectively removed from pure titanium implants with egg and flame shaped periimplantitis instruments. These instruments are also suitable for efficiently smoothing the implant surface.

Depending on the accessibility of the implant and the implant neck/shoulder, the operator can choose between egg or flame shaped instruments.

The instruments come with a long shank 310 and reach a total length of 30 mm.

Both instruments are also available with ultra-fine toothing. Provided with a white identification ring, these instruments are designed to create particularly smooth surfaces. The instruments were developed in cooperation with Dr. Martin Dürholt.

Advantages:

- Total length of 30 mm: Deeper regions can be reached with ease
- Smooth result: The instruments come with a normal and an ultra-fine toothing. Used in combination, these can achieve a remarkably smooth surface which helps to prevent new deposits of plaque
- All instruments are available as handy kits in laser-etched stainless steel bur blocks

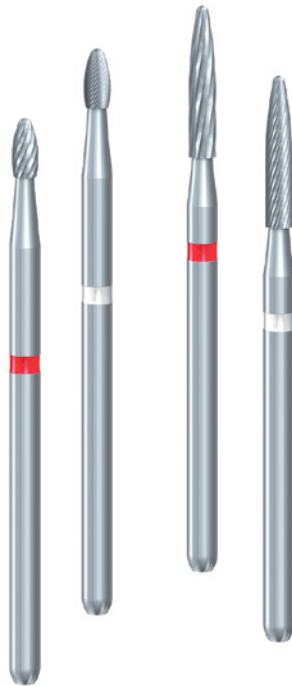

Periimplantitisbehandlung

Im Rahmen einer chirurgischen Periimplantitisbehandlung bei resektiver Strategie ist die Implantatglättung/Implantoplastik ein wichtiger Schritt zur Dekontaminierung der Oberflächenstruktur eines Implantates.

Mit Hilfe der Periimplantitisinstrumente Ei und Flamme können Makro- und Mikrostrukturen eines Implantates aus Reintitan effektiv entfernt und die Oberfläche optimal geglättet werden.

Abhängig von der Zugänglichkeit des Implantates und des Implantathalses/Schulter werden eiförmige oder flammenförmige Instrumente eingesetzt.

Die lange Gesamtlänge von 30 mm wird dank der Schaftart 310 erreicht. Zur Erzielung einer besonders glatten Oberfläche stehen beide Instrumente auch als Weißring mit ultrafeiner Verzahnung zur Verfügung. Die Instrumente wurden gemeinsam mit Dr. Martin Dürholt entwickelt.

Vorteile:

- 30 mm Gesamtlänge: tiefe Areale werden problemlos erreicht
- glattes Ergebnis: eine normale und eine ultrafeine Verzahnung sorgen kombiniert eingesetzt für eine besonders glatte Oberfläche, neue Belagsbildung wird erschwert
- alle Instrumente sind im praktischen Set im belasteten Instrumentenständer aus Edelstahl erhältlich



4656.310



Periimplantitis-Set für die intraorale Bearbeitung und Glättung von Titanimplantaten im Rahmen einer chirurgischen/resektiven Periimplantitisbehandlung, nach Dr. Martin Dürholt
Periimplantitis-Set for oral work and smoothing of titanium implants as part of the surgical/resective treatment of periimplantitis, according to Dr. Martin Dürholt

●	H379.310.014	1	
●	H379.310.023	1	
●	H48L.310.014	1	
●	H48L.310.023	1	
○	H379UF.310.014	1	
○	H379UF.310.023	1	
○	H48LUF.310.014	1	
○	H48LUF.310.023	1	

Rotierende Instrumente Ei und Flamme, Gesamtlänge 30 mm, im sterilisierbaren Instrumentenständer 9989
Rotary instruments egg and flame, instrument length 30 mm each, in a sterilizable bur block 9989

● **H 379**

Größe · Size	Ø 1/10 mm	014	023
L	mm	3,1	4,2

FG Chirurgie XL · FGSXL

● **H379.310. ...** 014 023

○_{max} 80000 min⁻¹/rpm
Ei für die intraorale Bearbeitung und Glättung von Titanimplantaten im Rahmen einer chirurgischen/resektiven Periimplantitisbehandlung, Gesamtlänge 30 mm
12 Schneiden, normal
Egg/Football for oral work and smoothing of titanium implants as part of the surgical/resective treatment of periimplantitis, instrument length 30 mm
12 blades, normal

○ **H 379 UF**

Größe · Size	Ø 1/10 mm	014	023
L	mm	3,1	4,2

FG Chirurgie XL · FGSXL

○ **H379UF.310. ...** 014 023

○_{max} 80000 min⁻¹/rpm
Ei für die intraorale Bearbeitung und Glättung von Titanimplantaten im Rahmen einer chirurgischen/resektiven Periimplantitisbehandlung, Gesamtlänge 30 mm
30 Schneiden, ultrafein
Egg/Football for oral work and smoothing of titanium implants as part of the surgical/resective treatment of periimplantitis, instrument length 30 mm
30 blades, ultra-fine

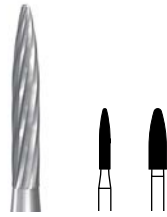

● **H 48 L**



		5	5
Größe · Size	Ø 1/10 mm	014	023
L	mm	8,0	8,0

FG Chirurgie XL · FGSXL



● **H48L.310. ...** 014 023

○_{max} 80000 min⁻¹/rpm

Flamme für die intraorale Bearbeitung und Glättung von Titanimplantaten im Rahmen einer chirurgischen/resektiven Periimplantitisbehandlung, Gesamtlänge 30 mm

12 Schneiden, normal

Flame for oral work and smoothing of titanium implants as part of the surgical/resective treatment of periimplantitis, instrument length 30 mm

12 blades, normal

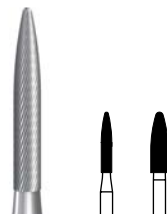

○ **H 48 LUF**



		5	5
Größe · Size	Ø 1/10 mm	014	023
L	mm	8,0	8,0

FG Chirurgie XL · FGSXL



○ **H48LUF.310. ...** 014 023

○_{max} 80000 min⁻¹/rpm

Flamme für die intraorale Bearbeitung und Glättung von Titanimplantaten im Rahmen einer chirurgischen/resektiven Periimplantitisbehandlung, Gesamtlänge 30 mm

Größe 014: 20 Schneiden, Gr. 023: 30 Schneiden, ultrafein

Flame for oral work and smoothing of titanium implants as part of the surgical/resective treatment of periimplantitis, instrument length 30 mm

Size 014: 20 blades, size 023: 30 blades, ultra-fine



Universelle Pilotbohrer Implantologie

Universal pilot burs for use in Implantology

The universal pilot burs are ideally suited for the initial preparation of the axis and depth of an implant site. If an implant with large diameter is to be placed, it is recommended to enlarge the perforation gradually.

The pilot burs with particularly small diameter can be used for palpating the implant position, perforation of bone cylinders as well as for creating a continuous perforation line during bone spreading.

Advantages:

- Large chip spaces for good chip removal
- Pyramid-shaped, special instrument tip for easy penetration
- Effective cutting
- Lasered depth markings at intervals of 2 mm, starting at 8 mm from the instrument tip
- Size and instrument length lasered on to the shank for easy identification

Mit den universellen Pilotbohrern lassen sich die Achse und Tiefe eines geplanten Implantatbettes optimal vorpräparieren. Ist die Insertion eines Implantatkörpers größeren Durchmessers geplant, empfiehlt sich die schrittweise Erweiterung der Bohrung.

Die Pilotbohrer mit besonders kleinen Durchmessern können für eine Palpation der Implantatposition oder zur Perforation von Knochenblöcken verwendet werden sowie im Rahmen einer Kieferkammspreizung zur Gestaltung einer fortlaufenden Perforationslinie.

Vorteile:

- große Spannuten für eine optimale Spanabfuhr
- pyramidenförmige, speziell gestaltete Instrumentenspitze für gutes Eintauchen
- effektives Schneidverhalten
- gelaserte Tiefenmarkierungen im Abstand von 2 mm, beginnend bei 8 mm (nach Instrumentenspitze)
- auf den Schaft gelaserte Größe und Instrumentenlänge zur raschen Identifikation

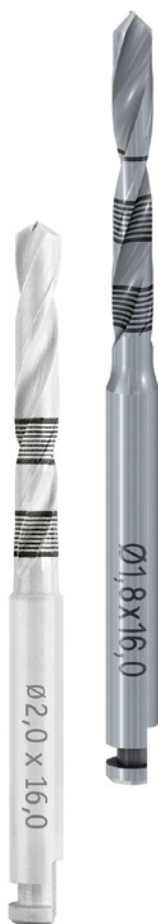

	210L16.205.008	L = 35 mm L ¹ = 0,3 mm
	210L16.205.010	L = 35 mm L ¹ = 0,4 mm
	210L16.205.013	L = 35 mm L ¹ = 0,6 mm
	210L16.205.018	L = 35 mm L ¹ = 0,8 mm
	210L16.204.020	L = 30,5 mm L ¹ = 0,8 mm
	210L16.204.028	L = 32 mm L ¹ = 1,2 mm

	210L19.204.020	L = 33,5 mm L ¹ = 0,8 mm		210L20.205.020	L = 41 mm L ¹ = 0,8 mm
	210L19.204.028	L = 35 mm L ¹ = 1,2 mm		210L20.205.028	L = 41 mm L ¹ = 1,2 mm

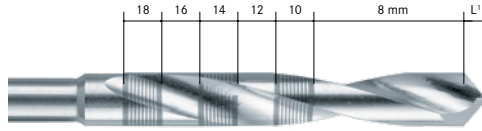

⊙_{max} 800 - 1.000 min⁻¹/rpm ⊙_{max} 6.000 min⁻¹/rpm
Rostfreier Stahl · Stainless steel

210 L 16
210 L 19
210 L 20

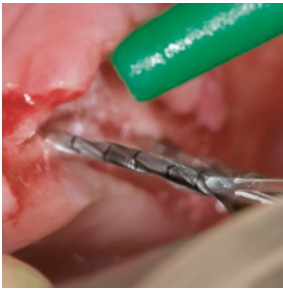
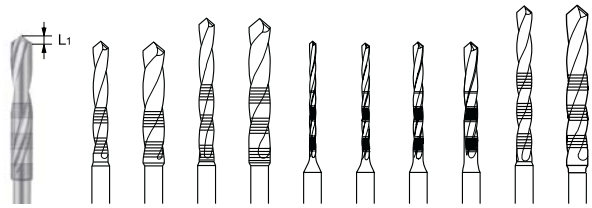

		2	2	2	2	2	2	2	2	2	
Größe · Size	Ø 1/10 mm	020	028	020	028	008	010	013	018	020	028
L	mm	16,0	16,0	19,0	19,0	16,0	16,0	16,0	16,0	20,0	20,0
L₁	mm	0,8	1,2	0,8	1,2	0,3	0,4	0,6	0,8	0,8	1,2

Winkelstück · Right-angle (RA)



210L16.204. ...	020	028	-	-	-	-	-	-	-	-	-
------------------------	-----	-----	---	---	---	---	---	---	---	---	---

210L19.204. ...	-	-	020	028	-	-	-	-	-	-	-
------------------------	---	---	-----	-----	---	---	---	---	---	---	---

Winkelstück lang · Right-angle long (RAL)



210L16.205. ...	-	-	-	-	008	010	013	018	-	-	-
------------------------	---	---	---	---	-----	-----	-----	-----	---	---	---

210L20.205. ...	-	-	-	-	-	-	-	-	-	020	028
------------------------	---	---	---	---	---	---	---	---	---	-----	-----

⊙_{max} 6000 min⁻¹/rpm
Pilotbohrer für die Implantologie, rostfreier Stahl
Tiefenmarkierung = 6, 8, 10, 12, 14 mm bei Gr. 008-018,
8, 10, 12, 14 (16, 18) mm bei Gr. 020-028
Pilot bur for implantology, stainless steel
Depth marking = 6, 8, 10, 12, 14 mm for sizes 008-018,
8, 10, 12, 14 (16, 18) mm for sizes 020-028

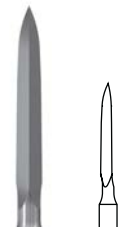

186 A



		1
Größe · Size		1
L	mm	12,0

Winkelstück · Right-angle (RA)



186A.204. ...	1
----------------------	---

⊙_{max} 100000 min⁻¹/rpm
MaxilloPrep Spread-Condense
Dreikantbohrer zum Ankörnen des Knochens, rostfreier Stahl
MaxilloPrep Spread-Condense
Triangular bur for centering bones, stainless steel

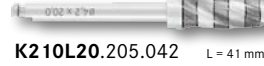
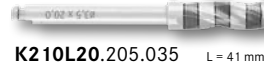
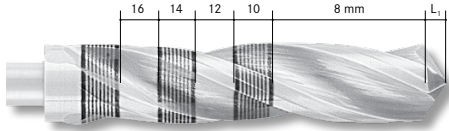
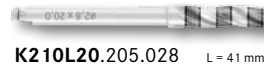
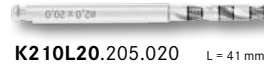
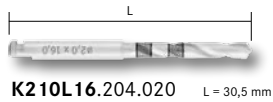

K 210 L 16
K 210 L 19
K 210 L 20

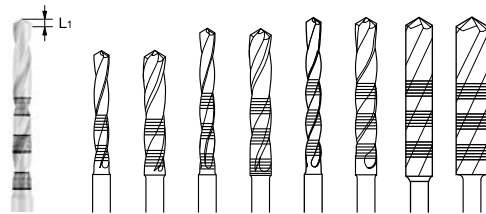

		1	1	1	1	1	1	1	1
Größe · Size	Ø 1/10 mm	020	028	020	028	020	028	035	042
L	mm	16,0	16,0	19,0	19,0	20,0	20,0	20,0	20,0
L₁	mm	0,6	0,8	0,6	0,8	0,6	0,8	1,1	1,3

Winkelstück · Right-angle (RA)



K210L16.204. ...	020	028	-	-	-	-	-	-	-
-------------------------	-----	-----	---	---	---	---	---	---	---

K210L19.204. ...	-	-	020	028	-	-	-	-	-
-------------------------	---	---	-----	-----	---	---	---	---	---

Winkelstück lang · Right-angle long (RAL)



K210L20.205. ...	-	-	-	-	020	028	035	042	-
-------------------------	---	---	---	---	-----	-----	-----	-----	---

○_{max} 6000 min⁻¹/rpm

Gebrauchsmuster, Patente / Utility model, patents

DE 10 2006 042 762

EP 1 539 018*

* angemeldet / * pending

Pilotbohrer für die Implantologie, Keramik
Tiefenmarkierung = 8, 10, 12, 14 (16, 18) mm
Pilot bur for implantology, made of ceramics
Depth marking = 8, 10, 12, 14 (16, 18) mm



Trepanbohrer, RF-Stahl

Trepan Burs, Stainless steel

The following two trepan burs with different designs are intended for the creation of different kinds of hollow perforations.

227A | Safe explantation

- High-efficiency toothing specially designed for cutting bone, laser depth markings to permit precise exposure of the implants to the required depth, large openings in the working part for a better view of the surgical site.

227B | Preparation of bone cylinders

- High-efficiency toothing specially designed for preparing bone cylinders with a diameter of 2.9 to 5.9, available in different lengths.

Zwei unterschiedlich konzipierte Trepanbohrer sind dienliche Instrumente für verschiedene Arten von Hohlbohrungen.

227A | Sicheres Explantieren

- schnitffreudige Verzahnung, aufgelaserte Markierungen für tiefengenaues Freilegen, große Fenster im Arbeitsbereich für gute Sicht

227B | Knochenzylindergewinnung

- schnitffreudig, zur Präparation von Knochenzylindern von \varnothing 2,9 bis 5,9 mm in verschiedenen Längen

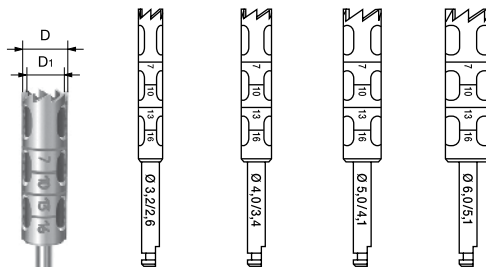
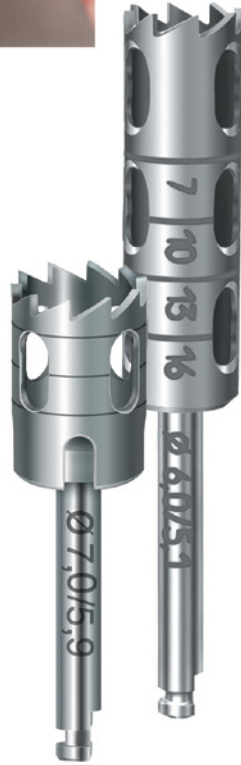

227 A



		1	1	1	1
Größe · Size	\varnothing $\frac{1}{10}$ mm	032	040	050	060
D	\varnothing $\frac{1}{10}$ mm	32	40	50	60
D ₁	\varnothing $\frac{1}{10}$ mm	26	34	41	51
L	mm	18	18	18	18

Winkelstück · Right-angle (RA)



227A.204. ...

032 040 050 060

\odot_{max} 6000 min⁻¹/rpm

Trepanbohrer zum Explantieren, rostfreier Stahl
Trepan bur for explantation, stainless steel

227 B

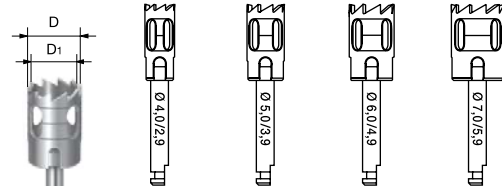

		1	1	1	1
Größe · Size	Ø 1/10 mm	040	050	060	070
D	Ø 1/10 mm	40	50	60	70
D ₁	Ø 1/10 mm	29	39	49	59
L	mm	8	8	8	8

Winkelstück · Right-angle (RA)



227B.204. ...

040 050 060 070

⊙_{max} 6000 min⁻¹/rpm

Trepanbohrer zur Präparation von Knochenzylindern, rostfreier Stahl

Trepan bur for preparation of bone cylinders, stainless steel

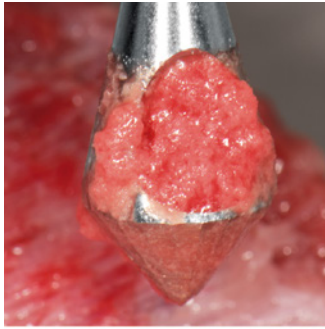

Bone chip extractor

The innovative bone chip extractor 9126 as suggested by Dr. Stefan Neumeyer is used for precise, yet gentle removal of bone chips.

- After exposing the bone substance by means of a very thin cut, the bone chip extractor is axially positioned on the bone. The self-centring tip penetrates the bone substance and the funnel-shaped bone chip extractor fills with moist bone chips.



Knochenspanbohrer

Der innovative Knochenspanbohrer 9126 nach Dr. Stefan Neumeyer präpariert gezielt Knochenspäne, bei sehr geringer Belastung des Spendeareals.

- nach Darstellung des Knochens durch einen nur sehr kleinen Schnitt wird der Knochenspanbohrer axial auf den Knochen aufgesetzt. Die Spitze zentriert sich sanft rotierend in Position. Anschließend füllt sich das trichterförmige Arbeitsteil mit feuchten Knochenspänen.

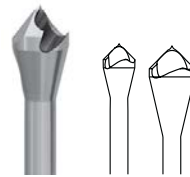

9126

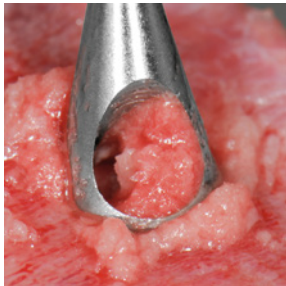

		1	1
Größe - Size	Ø 1/10 mm	042	060
L	mm	7,0	12,0

Winkelstück - Right-angle (RA)



9126.204. ...

○042 ●060

- = O_{max} 10000 min⁻¹/rpm
- = O_{max} 15000 min⁻¹/rpm

MaxilloPrep Knochenspanbohrer zur Gewinnung autologer Knochenspäne, rostfreier Stahl
MaxilloPrep bone chip extractor, drill for gaining a quantity of bone chips, stainless steel



Dr. Ivo Agabiti,
Pesaro, Italien

Sonic tips for surgery

Extremely fine incisions in bones

Developed in close cooperation with Dr. Ivo Agabiti from Pesaro, Italy, these sonic tips are a great leap forward in the quality of oral surgery. The innovative tips allow particularly gentle, conservative work on bones within the scope of restorations involving implants.

The sonic tips SFS100, SFS101 and SFS102 are indicated for splitting of the crest and lateral incisions in the bone as part of bone spreading treatments and for gentle extraction of a tooth from its alveolar compartment.

The saucer-shaped sonic tips SFS103 and SFS104 as well as the oval SFS105 are particularly suited for gently detaching the sinus membrane within the course of an external sinus lift operation.

SFS 100/101/102:

- The extremely fine cuts of merely 0.25 mm guarantee maximum conservation of substance in the bone structure
- The blade length of 10.7 mm provides sufficient penetration depth to allow vertical countersinking into the spongy bone; the width of the blade is 3.5 mm
- Thanks to their oscillating movements, the tips are particularly gentle on the soft tissue
- The sonic tips are used in oscillating mode in a suitable sonic hand piece, e.g. Komet SF1LM or SF1LS, which is placed on a dental turbine. A special motor is not required. The operating frequency of the oscillating, elliptic movements is approx. 6,000 Hz. The sonic tips 100-102 are also available with a Quick thread for connection with sonic handpieces Quick
- Sterile cooling solution is supplied via a cooling adapter equipped with small tubes that are screwed in between the sonic hand piece and the sonic tip

Chirurgische Schallspitzen

Extrem feine Knochenschnitte

SonicLine Schallspitzen für die Chirurgie sind ein Qualitätssprung in der oralen Chirurgie. Ihre Entwicklung erfolgte gemeinsam mit Dr. Ivo Agabiti aus Pesaro, Italien. Durch diese innovativen Spitzen eröffnet sich die Möglichkeit einer besonders substanzschonenden Knochenbearbeitung im Rahmen implantologischer Maßnahmen.

Die Schallspitzen SFS100, SFS101 und SFS102 sind indiziert für Osteotomien, crestale und laterale Knochenschnitte bei Kieferkamm Spreizung (Splitting) und helfen beim schonenden Lösen eines Zahnes aus seinem Alveolarfach bei Extraktion.

Die tellerförmigen Schallspitzen SFS103, SFS104 und die ovale SFS105 eignen sich ideal für das schonende Lösen der Sinusmembran im Rahmen einer externen Sinuslift-OP.

SFS 100/101/102:

- die extrem feine Schnittstärke von nur 0,25 mm gewährleistet maximalen Substanzerhalt der knöchernen Struktur
- die Schneidenlänge von 10,7 mm sorgt für genügend Eindringtiefe für ein vertikales Versenken in die Spongiosa; die Schneidenbreite beträgt 3,5 mm
- Weichgewebe wird aufgrund der oszillierenden Arbeitsweise besonders geschont
- der Einsatz erfolgt oszillierend in einem geeigneten Schallhandstück, z. B. dem Komet SF1LM oder SF1LS, das auf die zahnärztliche Turbine aufgesteckt wird. Ein spezieller Motor ist nicht erforderlich. Die oszillierende, elliptische Bewegung erfolgt mit ca. 6 000 Hz. Die Schallsägen 100-102 sind auch mit Quick-Gewinde für Schallhandstücke Quick erhältlich
- steriles Kühlmedium wird von extern über einen Kühladapter mit Röhrchen zugeführt, der zwischen Schallhandstück und Schallspitze eingeschraubt ist



SonicLine

© 419093 | © 10008722



SonicLine Quick

© 417641 | © 418065

Split Crest

Split crest

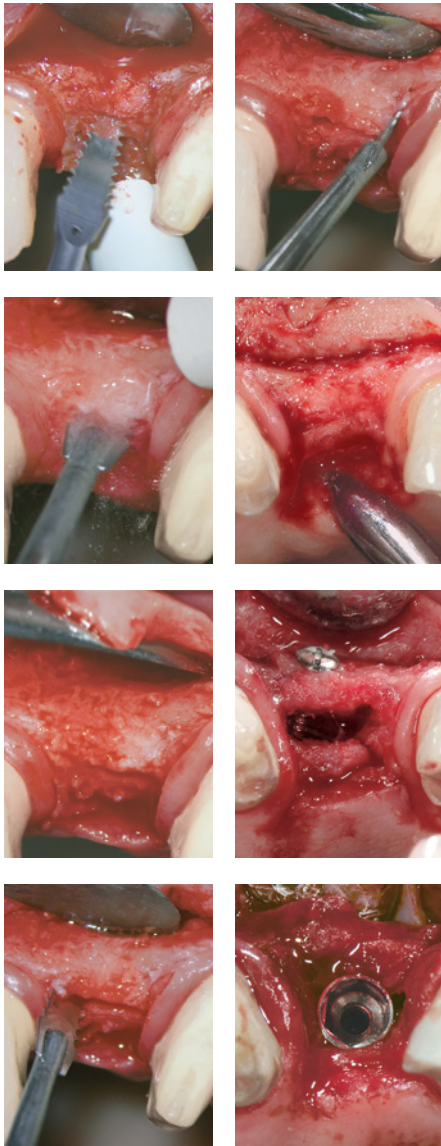

Entfernung Zahnkeim

Removing the dental germ



Externer Sinuslift

External sinus lift

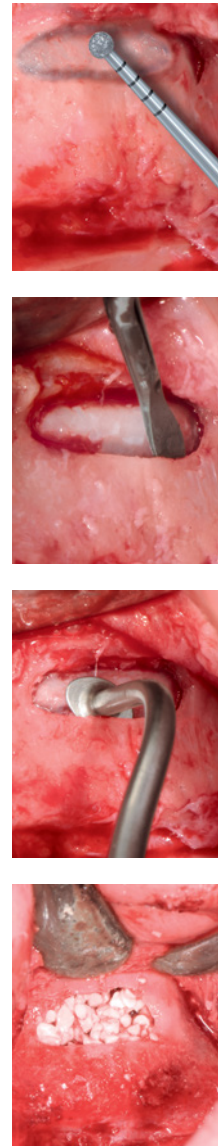



SFS 101

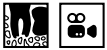

	1
--	---

SFS101.000. ...	•
---------------------------------	---

Axial
Schnittstärke 0,25 mm, Schneidentiefe 10,7 mm
Rostfreier Stahl
Axial
Cutting thickness 0.25 mm, cutting depth 10.7 mm
Stainless steel



SFS 100



	1
--	---

SFS100.000. ...	•
---------------------------------	---

Sagittal
Schnittstärke 0,25 mm, Schneidentiefe 10,7 mm
Rostfreier Stahl
Sagittal
Cutting thickness 0.25 mm, cutting depth 10.7 mm
Stainless steel



SFS 102



	1
--	---

SFS102.000. ...	•
---------------------------------	---

Gerade
Schnittstärke 0,25 mm, Schneidentiefe 10,7 mm
Rostfreier Stahl
Straight
Cutting thickness 0.25 mm, cutting depth 10.7 mm
Stainless steel

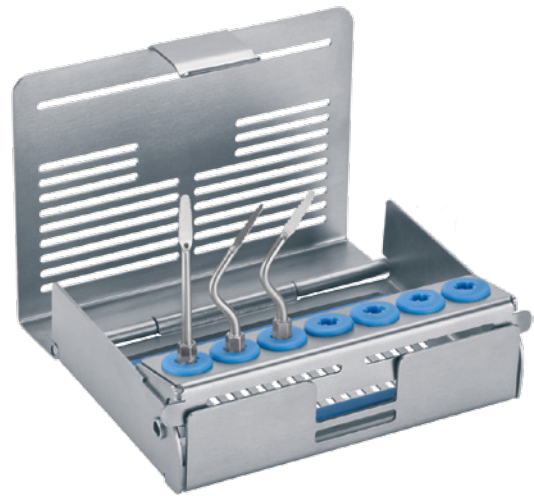

4567 A.000



Set Schallspitzen für die Oralchirurgie nach Dr. Ivo Agabiti
Set sonic tips for oral surgery, according to Dr. Ivo Agabiti

	1	
SFS100.000.	1	
	1	
SFS101.000.	1	
	1	
SFS102.000.	1	
9952.000.	1	



SFSQ 101



1

[SFSQ101.000. ...](#) •

Axial, Quick Anschluss
Schnittstärke 0,25 mm, Schneidentiefe 10,7 mm
Rostfreier Stahl
Axial, Quick connection
Cutting thickness 0.25 mm, cutting depth 10.7 mm
Stainless steel



SFSQ 100



1

[SFSQ100.000. ...](#) •

Sagittal, Quick Anschluss
Schnittstärke 0,25 mm, Schneidentiefe 10,7 mm
Rostfreier Stahl
Sagittal, Quick connection
Cutting thickness 0.25 mm, cutting depth 10.7 mm
Stainless steel



SFSQ 102



1

[SFSQ102.000. ...](#) •

Gerade, Quick Anschluss
Schnittstärke 0,25 mm, Schneidentiefe 10,7 mm
Rostfreier Stahl
Straight, Quick connection
Cutting thickness 0.25 mm, cutting depth 10.7 mm
Stainless steel

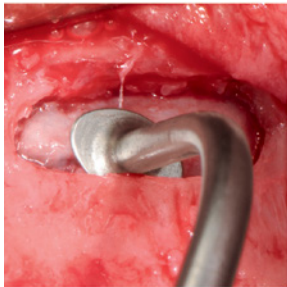
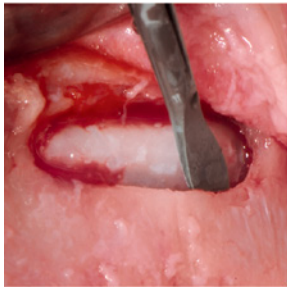
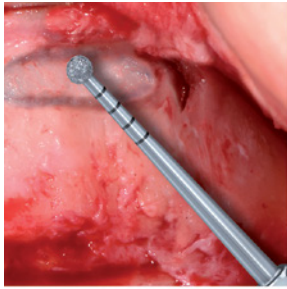

Sinuslift lateral

Lateral sinus lift

Developed by Dr. Ivo Agabiti, these sonic tips are designed for the initial preparation of the bony window and for the minimally invasive mobilization of the periosteal membrane in the maxillary sinus as part of a sinus lift.

Indication:

- Final preparation of the bone window
- Gentle separation of the sinus membrane in the area of the previously mobilized lateral window
- Gentle elevation of the sinus membrane

Advantages:

- The saucer shaped sonic tips SFS103 or SFS104 are particularly suited for hard-to-reach edges of the lateral window
- The oval sonic tip SFS105 gently detaches the periosteal membrane at the edges of the lateral window

Schallspitzen für die initiale Präparation des Knochenfensters und die schonende Mobilisierung der Kieferhöhlenschleimhaut im Rahmen einer externen Sinuslift-OP, entwickelt mit Dr. Ivo Agabiti, Italien

Indikation:

- finale Präparation des Knochenfensters
- schonende Separation der Sinusmembran im Bereich des zuvor mobilisierten Knochenfensters
- schonende Elevation der Sinusmembran

Vorteile:

- die tellerförmigen Schallspitzen SFS103 und SFS104 erreichen auch schwierigste Rundungen
- die ovale Schallspitze SFS105 löst sanft die Verbindung im Bereich der Knochenfensterränder

SFS 109



		1
Größe · Size	∅ 1/10 mm	025
D	∅ 1/10 mm	25

SFS109.000. ...

025

Diamantiert, rund, gerade, zur Präparation des Knochenfensters/
externer Sinuslift
Rostfreier Stahl
*Diamond coated, round, straight, for the preparation of a lateral window/
external sinus lift
Stainless steel*

SFS 109 F



		1
Größe · Size	∅ 1/10 mm	025
D	∅ 1/10 mm	25

SFS109F.000. ...

025

Diamantiert, rund, gerade, Feinkorn, zur Präparation des
Knochenfensters/externer Sinuslift
Rostfreier Stahl
*Diamond coated, round, straight, fine grit, for the preparation of a lateral
window/external sinus lift
Stainless steel*



SFS 103



1

SFS103.000. ...

Tellerförmig ca. Ø 2,5 mm, Winkel 75°
Zum Lösen der Schneiderschen Membran/externer Sinuslift
Rostfreier Stahl
Saucer-shaped approx. Ø 2.5 mm, angle 75°
Separation of the Schneider membrane/external sinus lift
Stainless steel



SFS 104



1

SFS104.000. ...

Tellerförmig ca. Ø 2,5 mm, Winkel 35°
Zum Lösen der Schneiderschen Membran/externer Sinuslift
Rostfreier Stahl
Saucer-shaped approx. Ø 2.5 mm, angle 35°
Separation of the Schneider membrane/external sinus lift
Stainless steel



SFS 105



1

SFS105.000. ...

Oval (Elefantenfuß), ca. 3,5 x 5,2 mm, Winkel 60°
Zum Lösen der Schneiderschen Membran/externer Sinuslift
Rostfreier Stahl
Oval (elephant foot), approx. 3.5 x 5.2 mm, angle 60°
Separation of the Schneider membrane/external sinus lift
Stainless steel

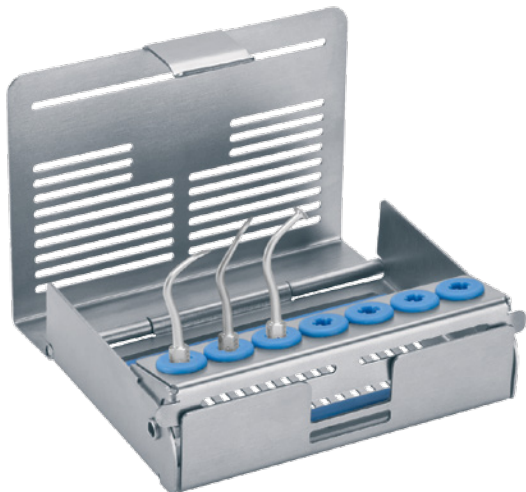

4614.000



Set Sono Membran Stericassette
Set Sono Membrane sterilisation container

SFS103.000.	1	
SFS104.000.	1	
SFS105.000.	1	
9952.000.	1	



9952.000



Abmessungen · Dimensions mm 90 x 65 x 22

Instrumentenständer aus rostfreiem Edelstahl mit 7 Aufnahmen für Schall- oder Ultraschallspitzen und vormontierten hellblauen Silikonstopfen
Bur block made of stainless steel with 7 holders for sonic or ultrasonic tips and preassembled light blue silicone plugs



Knochenbearbeitung



Bone preparation

Diamond coated, tapered sonic tip for vertical incisions in the bone at the mesial and distal end during the widening of the alveolar ridge

Indication:

- Bone removal (Osteotomy)
- Shaping of bones (Osteoplasty)

Advantages:

- Gentle, conservative work on bones
- Excellent control
- Particularly gentle on soft tissue

Hint:

For further information, we recommend our surgery brochure.

Diamantierte konische Schallspitze für vertikale Knochenschnitte mesial und distal im Rahmen einer Kieferkammverbreiterung

Indikation:

- Knochenabtrag (Osteotomie)
- Knochenmodellation (Osteoplastik)

Vorteile:

- substanzschonende Knochenbearbeitung
- hohe Kontrollierbarkeit
- maximale Schonung des Weichgewebes

Tipp:

Wir empfehlen unsere Chirurgiebrochure.



SFS 110



		1
L	mm	10,0
Winkel · Angle	α	3°

SFS 110.000. ...

Diamantiert, konisch
Rostfreier Stahl
*Diamond coated, tapered
Stainless steel*



Dr. Thomas Schwenk



Dr. Marcus Striegel



Sonic tips SFS120/121/122

Minimally invasive surgical crown extension

The sonic tips SFS120, SFS121 and SFS122 facilitate minimally invasive surgical crown extension without the creation of a flap. These sonic tips were developed in close cooperation with Dr. Thomas Schwenk and Dr. Marcus Striegel, Nuremberg, Germany. They carry out a surgical crown extension for example in cases where the biological width has been violated or when an asymmetric dental arcade or a "gummy smile" are to be rectified.

- *The tip is available in two diameters, allowing an optimal aesthetic treatment of the eye-catching areas. SFS120: Size 020 for teeth 2 and 4, size 030 for teeth 1 and 3.*

- *Posterior use: Even in the posterior region, the bone is often too close to the crown margin.*

- *The treatment is carried out in the tried and tested clinical manner: Having measured the patient's individual biological width, the treatment is planned with the help of a mock-up, wax-up or template. After the subsequent gingival correction, the osteotomy to recreate the biological width without creation of a flap is carried out with the sonic tip by slightly pivoting the tip in mesial and distal direction.*

- *To be used in a suitable sonic hand piece, e.g. Komet SF1LM or SF1LS. The sonic tips 120-122 are also available with a Quick thread for connection with sonic handpieces Quick*



Schallspitzen SFS120/121/122

Minimalinvasive chirurgische Kronenverlängerung

Die Schallspitzen SFS120/SFS121 und SFS122 unterstützen eine minimalinvasive chirurgische Kronenverlängerung ohne Lappenbildung. Entwickelt wurden sie mit Dr. Thomas Schwenk und Dr. Marcus Striegel aus Nürnberg.

Die chirurgische Kronenverlängerung wird von ihnen u.a. durchgeführt bei vorliegender Verletzung der biologischen Breite, bei unsymmetrischem Arkadenverlauf und auch bei einem sog. Gummy Smile.

- zwei Durchmesser gewährleisten die Versorgung der ästhetischen Einsatzbereiche für einen harmonischen Verlauf. SFS120: Größe 020 für die Zähne 2 und 4, Größe 030 für die Zähne 1 und 3

- Einsatz posterior: auch im Seitenzahn-bereich ist der Knochen häufig zu nah am Kronenrand

- die Anwendung erfolgt in klinisch erprobter Weise: nach Messung der individuellen biologischen Breite erfolgt die Planung mittels Mock-Up, Wax-Up oder Schablone. Nach der anschließenden Gingivakorrektur wird die Osteotomie zur Wiederherstellung der biologischen Breite mit der Schallspitze ohne Lappenbildung durchgeführt – durch leichtes Schwenken nach mesial und distal

- der Einsatz erfolgt in einem geeigneten Schallhandstück, z. B. dem Komet SF1LM oder SF1LS. Die Schallspitzen 120-122 sind auch mit Quick-Gewinde für Schallhandstücke Quick erhältlich



SFS 120



		1	1
Größe · Size	Ø 1/10 mm	020	030
SFS120.000. ...		020	030

Gebrauchsmuster, Patente/ Utility model, patents
EP 2 145 598

Minimalinvasive chirurgische Kronenverlängerung
Rostfreier Stahl
Minimally invasive surgical crown extension
Stainless steel

Verletzung der biologischen Breite

Damage to the biological width



Unsymmetrischer Arkadenverlauf

Asymmetrical dental arcade



Gummy Smile

Gummy Smile



SFS 121



		1	1
Größe · Size	Ø 1/10 mm	020	030
SFS121.000. ...		020	030

Gebrauchsmuster, Patente/ Utility model, patents
EP 2 145 598

Minimalinvasive chirurgische Kronenverlängerung
Rostfreier Stahl
Minimally invasive surgical crown extension
Stainless steel



SFS 122



		1	1
Größe · Size	Ø 1/10 mm	020	030
SFS122.000. ...		020	030

Gebrauchsmuster, Patente/ Utility model, patents
 EP 2 145 598

Minimalinvasive chirurgische Kronenverlängerung
 Rostfreier Stahl
 Minimally invasive surgical crown extension
 Stainless steel



SFSQ 120



		1	1
Größe · Size	Ø 1/10 mm	020	030
SFSQ120.000. ...		020	030

Gebrauchsmuster, Patente/ Utility model, patents
 EP 2 145 598

Minimalinvasive chirurgische Kronenverlängerung, Quick Anschluss
 Rostfreier Stahl
 Minimally invasive surgical crown extension, Quick connection
 Stainless steel



SFSQ 121



		1	1
Größe · Size	Ø 1/10 mm	020	030
SFSQ121.000. ...		020	030

Gebrauchsmuster, Patente/ Utility model, patents
EP 2 145 598

Minimalinvasive chirurgische Kronenverlängerung, Quick Anschluss
Rostfreier Stahl
Minimally invasive surgical crown extension, Quick connection
Stainless steel



SFSQ 122



		1	1
Größe · Size	Ø 1/10 mm	020	030
SFSQ122.000. ...		020	030

Gebrauchsmuster, Patente/ Utility model, patents
EP 2 145 598

Minimalinvasive chirurgische Kronenverlängerung, Quick Anschluss
Rostfreier Stahl
Minimally invasive surgical crown extension, Quick connection
Stainless steel



Stainless steel bur blocks

A considerable number of rotary and oscillating instruments is used in the dental practice every day. Every practice team wishes to reprocess these instruments in a simple, ergonomic manner. In response, Komet offers a vast range of bur blocks for all types of instruments, for example for standard rotary instruments, endodontics and for sonic tips.

Our bur blocks are available in many different versions: big or small, high or deep. All bur blocks are clearly laid out and feature a long service life. Stainless steel bur blocks and tribune-like bur blocks are suitable for cleaning and disinfecting in the instrument or ultrasonic bath or in the thermo disinfectant. Komet has had the reprocessing of our instruments validated by an external institute. With Komet bur blocks and reprocessing instructions, our customers are always on the safe side.

Edelstahlstände

Das Aufkommen rotierender und oszillierender Instrumente in einer Praxis kann groß sein – Mengen, die jedes Team einfach und ergonomisch aufbereiten möchte. Dafür bietet Komet unterschiedlichste Instrumentenstände an: z. B. für das rotierende Standardsortiment, die Endodontie und die Schallspitzen.

Die Unterschiede: groß, klein, hoch, tief. Die Gemeinsamkeiten: Übersichtlichkeit und eine lange Haltbarkeit. Edelstahl- und Tribünenstände sind für das Instrumenten bzw. Ultraschallbad, den Thermodesinfektor und den Autoklav geeignet. Da wir die Aufbereitung unserer Instrumente durch ein externes Institut haben validieren lassen, sind Sie mit unseren Instrumentenständen und den Herstellerinformationen zur Instrumentenaufbereitung immer auf der sicheren Seite.



9993 L 6.000



Abmessungen · Dimensions mm 91 x 45 x 60

Instrumentenständer aus rostfreiem Edelstahl mit 6 Aufnahmen für FG- und Winkelstückinstrumente sowie 3 Aufnahmen für Schallinstrumente, mit vormontierten blauen Silikonstopfen, für eine max. Instrumentenlänge von 58 mm

Bur block made of stainless steel with 6 blue silicone plugs for FG and RA instruments and 3 plugs for sonic tips, for a maximum length of 58 mm



9933 L 3.000



Abmessungen · Dimensions mm 61 x 45 x 30

Instrumentenständer aus rostfreiem Edelstahl mit 12 Aufnahmen für FG- und Winkelstückinstrumente, mit vormontierten blauen Silikonstopfen, für eine max. Instrumentenlänge von 28 mm

Bur block made of stainless steel with 12 blue silicone plugs as universal instrument holders, for FG and RA instruments with a maximum length of 28 mm



9933 L 5.000



Abmessungen · Dimensions mm 61 x 45 x 50

Instrumentenständer aus rostfreiem Edelstahl mit 12 Aufnahmen für FG- und Winkelstückinstrumente, mit vormontierten blauen Silikonstopfen, für eine max. Instrumentenlänge von 48 mm

Bur block made of stainless steel with 12 blue silicone plugs as universal instrument holders, for FG and RA instruments with a maximum length of 48 mm



9933 L 6.000



Abmessungen · Dimensions mm 61 x 45 x 60

Instrumentenständer aus rostfreiem Edelstahl mit 12 Aufnahmen für FG- und Winkelstückinstrumente, mit vormontierten blauen Silikonstopfen, für eine max. Instrumentenlänge von 58 mm

Bur block made of stainless steel with 12 blue silicone plugs for FG and RA instruments with a maximum length of 58 mm



9933 L 7.000



Abmessungen · Dimensions mm 61 x 45 x 70

Instrumentenständer aus rostfreiem Edelstahl mit 12 Aufnahmen für FG- und Winkelstückinstrumente, mit vormontierten blauen Silikonstopfen, für eine max. Instrumentenlänge von 68 mm

Bur block made of stainless steel with 12 blue silicone plugs as universal instrument holders, for FG and RA instruments with a maximum length of 68 mm



9949 L 3.000



Abmessungen · Dimensions mm 79 x 63 x 30

Instrumentenständer aus rostfreiem Edelstahl mit 24 Aufnahmen für FG- und Winkelstückinstrumente, mit vormontierten blauen Silikonstopfen, für eine max. Instrumentenlänge von 28 mm

Bur block made of stainless steel with 24 blue silicone plugs for FG and RA instruments with a maximum length of 28 mm



9949 L 6.000



Abmessungen · Dimensions mm 79 x 63 x 60

Instrumentenständer aus rostfreiem Edelstahl mit 24 Aufnahmen für FG- und Winkelstückinstrumente, mit vormontierten blauen Silikonstopfen, für eine max. Instrumentenlänge von 58 mm

Bur block made of stainless steel with 24 blue silicone plugs for FG and RA instruments with a maximum length of 58 mm



9989.000



Abmessungen · Dimensions mm 83 x 45 x 35

Instrumentenständer aus rostfreiem Edelstahl mit 16 Aufnahmen für FG- und Winkelstückinstrumente, mit vormontierten blauen Silikonstopfen, für eine max. Instrumentenlänge von 33 mm

Bur block made of stainless steel with 16 blue silicone plugs as universal instrument holders, for FG and RA instruments with a maximum length of 33 mm



9990.000



Abmessungen · Dimensions mm 109 x 63 x 35

Instrumentenständer aus rostfreiem Edelstahl mit 30 Aufnahmen für FG- und Winkelstückinstrumente, mit vormontierten blauen Silikonstopfen, für eine max. Instrumentenlänge von 33 mm

Bur block made of stainless steel with 30 blue silicone plugs as universal instrument holders, for FG and RA instruments with a maximum length of 33 mm



9991.000



Abmessungen · Dimensions mm 109 x 80 x 35

Instrumentenständer aus rostfreiem Edelstahl mit 40 Aufnahmen für FG- und Winkelstückinstrumente, mit vormontierten blauen Silikonstopfen, für eine max. Instrumentenlänge von 33 mm

Bur block made of stainless steel with 40 blue silicone plugs as universal instrument holders, for FG and RA instruments with a maximum length of 33 mm



9992.000



Abmessungen · Dimensions mm 109 x 80 x 60

Instrumentenständer aus rostfreiem Edelstahl mit 40 Aufnahmen für FG- und Winkelstückinstrumente, mit vormontierten blauen Silikonstopfen, für eine max. Instrumentenlänge von 58 mm

Bur block made of stainless steel with 40 blue silicone plugs as universal instrument holders, for FG and RA instruments with a maximum length of 58 mm



9945.000



Abmessungen · Dimensions mm 147,5 x 79 x 49

Instrumentenständer aus rostfreiem Edelstahl mit 40 Aufnahmen für FG- und Winkelstückinstrumente, mit vormontierten blauen Silikonstopfen, für eine max. Instrumentenlänge von 45 mm

Bur block made of stainless steel with 40 blue silicone plugs for FG and RA instruments, for a maximal length of 45 mm

45



97510.000



Abmessungen · Dimensions mm 100 x 88 x 49

Instrumentenständer aus rostfreiem Edelstahl mit 21 Aufnahmen für FG- und Winkelstückinstrumente, mit vormontierten blauen Silikonstopfen, für eine max. Instrumentenlänge von 45 mm

Bur block made of stainless steel with 21 blue silicone plugs for FG and RA instruments, for a maximal length of 45 mm



Instrumentenständer | Edelstahlständer
Bur blocks | Stainless steel bur blocks



97511.000



Abmessungen · Dimensions mm 150 x 89 x 49

Instrumentenständer aus rostfreiem Edelstahl mit 35 Aufnahmen für FG- und Winkelstückinstrumente sowie 4 Aufnahmen für Schallinstrumente, mit vormontierten roten, grünen und blauen Silikonstopfen, für eine max. Instrumentenlänge von 45 mm
Bur block made of stainless steel with 35 red, green and blue silicone plugs for FG and RA instruments and 4 plugs for sonic tips, for a maximal length of 45 mm

46



9891



	1	1	1	1	1	1	1
Größe · Size	1	2	3	4	5	6	7

9891.000. ...	1	2	3	4	5	6	7
----------------------	---	---	---	---	---	---	---

Silikonstopfen, als Refill für Instrumentenständer mit
 Silikonstopfen, 8 Stück
Silicone plug, refill for bur blocks with silicone plugs, 8 pieces



9953



	7
Größe · Size	1

9953.000. ...	1
----------------------	---

Silikonstopfen, als Refill für Instrumentenständer 9952
 für Schallsitzen
Silicone plugs, refill for bur block 9952 for sonic tips



4602.000

Set Kühladapter SF1979 für Schallspitzen und Montageschlüssel 566
Set cooling adapter SF1979 for sonic tips and mounting wrench 566



SF1979.000.

1



566.000.

1



SF 1979.000

Kühladapter für Schallspitzen, zur externen Zuführung sterilen Kühlmediums
Rostfreier Stahl
Cooling adapter for sonic tips, for external supply of sterile cooling liquid
Stainless steel



4659.000

Set Kühladapter SFQ1979 für Schallspitzen Quick und Montageschlüssel 566
Set cooling adapter SFQ1979 for sonic tips Quick and mounting wrench 566



SFQ1979.000.

1

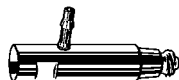

566.000.

1



SFQ 1979.000

Kühladapter für Schallspitzen, zur externen Zuführung sterilen Kühlmediums,
Quick Anschluss
Rostfreier Stahl
Cooling adapter for sonic tips, for external supply of sterile cooling liquid, Quick
connection
Stainless steel



566.000

Schlüssel für Kühladapter für Schall- und Ultraschallspitzen, Polymer-Pin SF1982
Rostfreier Stahl
Mounting wrench for cooling adapter for sonic and ultrasonic tips, polymer pin
SF1982
Stainless steel

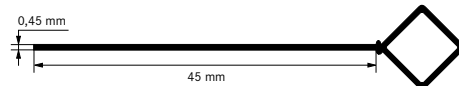

9793

Mandrin zum Reinigen der Kühlbohrungen bei innengekühlten Instrumenten,
rostfreier Stahl
Cleaning wire for cleaning the cooling orifices of internally cooled instruments,
stainless steel



SF 1978.000



Spüladapter zur Aufbereitung von Schallspitzen im Miele Reinigungs- und Desinfektionsgerät
Rinse adapter for reprocessing of sonic tips in a Miele washer/disinfector



SF 1978 L.000



Spüladapter lang zur maschinellen Aufbereitung von Schallspitzen im Miele Reinigungs- und Desinfektionsgerät
Rinse adapter long for the mechanical reprocessing of sonic tips in a Miele washer/disinfector



SF 1977.000



Spüladapter zur maschinellen Aufbereitung des Komet Kühladapters SF1979 und der Ultraschallspitzen mit Innengewinde (kompatibel mit EMS und KaVo PIEZOlux™ Einheiten) im Miele Reinigungs- und Desinfektionsgerät, rostfreier Stahl
Rinse adapter for reprocessing of the Komet cooling adapter SF1979 or of the ultrasonic tips with internal thread (compatible with EMS and KaVo PIEZOlux™ units) in a Miele washer/disinfector, stainless steel



SF 1977 L.000



Spüladapter lang zur maschinellen Aufbereitung des Komet Kühladapters SF1979 und der Ultraschallspitzen mit Innengewinde (kompatibel mit EMS und KaVo PIEZOlux™ Einheiten) im Miele Reinigungs- und Desinfektionsgerät, rostfreier Stahl
Rinse adapter long for reprocessing of the Komet cooling adapter SF1979 or of the ultrasonic tips with internal thread (compatible with EMS and KaVo PIEZOlux™ units) in a Miele washer/disinfector, stainless steel



SFQ 1978.000



Spüladapter zur Aufbereitung von Schallspitzen im Miele Reinigungs- und Desinfektionsgerät, Quick Anschluss
Rinse adapter for reprocessing of sonic tips in a Miele washer/disinfector, Quick connection



SFQ 1978 L.000



Spüladapter lang zur maschinellen Aufbereitung von Schallspitzen im Miele Reinigungs- und Desinfektionsgerät, Quick Anschluss
Rinse adapter long for the mechanical reprocessing of sonic tips in a Miele washer/disinfector, Quick connection



SFQ 1977.000



Spüladapter zur maschinellen Aufbereitung des Komet Kühladapters SFQ1979 und der Ultraschallspitzen mit Innengewinde (kompatibel mit EMS und KaVo PIEZOlux™ Einheiten) im Miele Reinigungs- und Desinfektionsgerät, Quick Anschluss, rostfreier Stahl

Rinse adapter for reprocessing of the Komet cooling adapter SFQ1979 or of the ultrasonic tips with internal thread (compatible with EMS and KaVo PIEZOlux™ units) in a Miele washer/disinfector, Quick connection, stainless steel



SFQ 1977 L.000



Spüladapter lang zur maschinellen Aufbereitung des Komet Kühladapters SFQ1979 im Miele Reinigungs- und Desinfektionsgerät, Quick Anschluss, rostfreier Stahl

Rinse adapter long for reprocessing of the Komet cooling adapter SFQ1979 in a Miele washer/disinfector, Quick connection, stainless steel



589



1

Winkelstück - Right-angle (RA)



589.204. ...

⊙_{max.} 15000 min⁻¹/rpm

Bohrerschaftverlängerung 15 mm für

Winkelschaftinstrumente

Rostfreier Stahl

Extension 15 mm for instruments with contra-angle shank

Stainless steel



9791



Reinigungsbürste, sterilisierbar
Metall-Handgriff mit austauschbarer Bürste aus rostfreiem Edelstahl zur
Reinigung und Pflege von rotierenden Instrumenten
*Metal cleaning brush, sterilizable
Metal handle with interchangeable brush made of stainless steel for cleaning and
maintenance of rotary instruments*



9792



Ersatzbürste aus Metall
Spare metal brush



9873



Reinigungsbürste aus Nylon, sterilisierbar
Metall-Handgriff mit austauschbarer Bürste aus Nylon zur Reinigung und Pflege
von rotierenden Instrumenten aus Keramik
*Nylon cleaning brush, sterilizable
Metal handle with interchangeable nylon brush for cleaning and maintenance of
rotary instruments made of ceramics*



9874



Ersatznylonbürste
Spare nylon brush

Periimplantitis

Implantatglättung mit rotierenden Hartmetallinstrumenten im Rahmen der chirurgisch/resektiven Strategie

Implantat smoothing with rotary tungsten carbide instruments during surgical resection



Ausgangssituation:

Implantatgetragene Stegkonstruktion mit Prothetikversorgung Regio 13 - 17. Gefräster NEM Steg

Initial situation:

Implant supported bar construction with prosthetic restoration, region 13 - 17, milled non-precious metal bar.

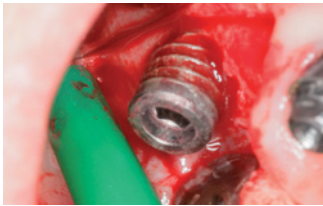

Darstellung des periimplantären

Knochendefektes 16 nach Abnahme des Steges

Exposure of the peri-implant bone defect 16 after removal of the bar.



Abtrag der makroskopischen Oberflächenstruktur mit dem Rotring Form Ei, H379 - unter Schonung der Implantatschulter! Auch bei nicht abnehmbaren Suprastrukturen lassen sich mit den 30 mm langen Instrumenten alle Areale gut erreichen

Removal of the macroscopic surface structure with the red-ring, egg-shaped instrument H379, taking care not to damage the implant shoulder. The instrument has a total length of 30 mm which enables it to reach all areas with ease, even in cases of non-removable superstructures.

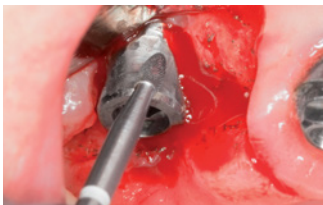

Das formkongruente ultrafeine Instrument erzeugt die gewünschte sehr feine Oberflächenstruktur. Eine Politur im eigentlichen Sinne, z. B. mit Silikonpolierern, wird aufgrund von Rückstandsbildung (Silikonfilm, Partikel) nicht erwogen

The required very fine surface is created with an ultrafine instrument of identical shape. We advise against proper polishing of the surface, for example with silicone polishers, because of the residues this would leave behind (silicon film, particles).



Die saubere Titanoberfläche nach der Bearbeitung. Man erkennt die erhaltene Anschlussgeometrie für das Implantat-abutment. Titanspäne wurden zuvor mit einer sterilen Nylonbürste entfernt

The clean titanium surface after treatment. The photo shows that the connection for the implant abutment is still intact. Any titanium chips have been removed with a sterile nylon brush beforehand.

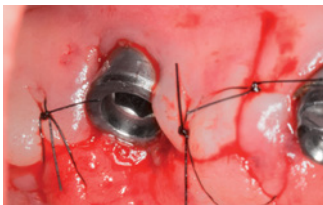

Wundverschluss. Kontrolle und Entfernung der Fäden nach 7 Tagen

Closure of the wound. Control and removal of the stitches after 7 days.



Wir empfehlen unsere Broschüren:
We recommend our brochures:



SonicLine
 CE 419093 | EN 10008722



SonicLine Quick
 CE 417641 | EN 418065



PiezoLine
 CE 410007 | EN 411782

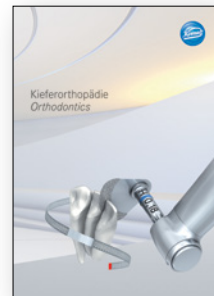

**Kieferorthopädie
 Orthodontics**
 CE EN 10001889



Bestellhilfe Hartmetall
Ordering Guide Tungsten Carbide
 CE EN 10000552

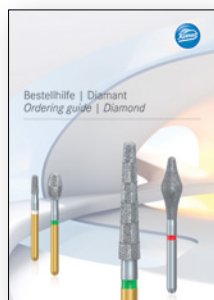

Bestellhilfe Diamant
Ordering Guide Diamond
 CE EN 10005525



**Herstellerinformation
 Schall- und Ultraschallschlitzen**
*Manufacturer's Information
 Sonic and Ultrasonic tips*
 CE 1005366 | EN 10010394



**Herstellerinformation
 Kritisch A und B**
*Manufacturer's Information
 Critical A and B*
 CE 10005346 | EN 10010390



Tipp:

Tipp: Besuchen Sie uns gerne unter www.kometdental.de oder unseren Shop: www.kometstore.de

Komet Dental

Gebr. Brasseler GmbH & Co. KG
Trophagener Weg 25 · 32657 Lemgo
Postfach 160 · 32631 Lemgo · Germany

Verkauf Deutschland:

Telefon +49 (0) 5261 701-700
Telefax +49 (0) 5261 701-289
info@kometdental.de
www.kometdental.de

Export:

Telefon +49 (0) 5261 701-0
Telefax +49 (0) 5261 701-329
export@kometdental.de
www.kometdental.de

Komet Austria Handelsagentur GmbH
Hellbrunner Straße 15
5020 Salzburg · Austria

Telefon +43 (0) 662 829-434
Telefax +43 (0) 662 829-435
info@kometdental.at
www.kometdental.at